

CARATTERISTICHE TECNICHE



NO POLVERE IN CANTIERE

Il telaio e i coprifili sono in legno multistrato che, al contrario dell'MDF, riduce molto la produzione di polvere quando viene rifilato.

SEMPLICITÀ DI PULIZIA

L'alta qualità dei materiali consente la pulizia del pannello porta con tutti i detergenti più comuni.

REVERSIBILITÀ

Un unico prodotto per quattro versi di apertura. Per la versione a battente l'imbotte è nel lato a spingere.

RESISTENZA

La finitura in laminato ha uno spessore di 6 decimi, pensato per resistere a graffi e urti senza compromessi sulla bellezza e la durata.

PROTEZIONE DALL'UMIDITÀ

Lo speciale trattamento stopwater sul lato inferiore consente una migliore resistenza all'umidità.

FINITURE PANNELLO PORTA

LAMINATO



BIANCO

LACCATO OPACO



BIANCO

FINITURE STIPITI, COPRIFILI E COMPENSATORI

LAMINATO



BIANCO

NOTE

La porta battente è dotata di cerniera pivot regolabile

Il "pacchetto POP" è venduto comprensivo di pannello porta, stipiti e coprifili

Porte **LEGNO** | ECLISSE **Classic Collection** - variante **POP**

PORTA SCORREVOLE

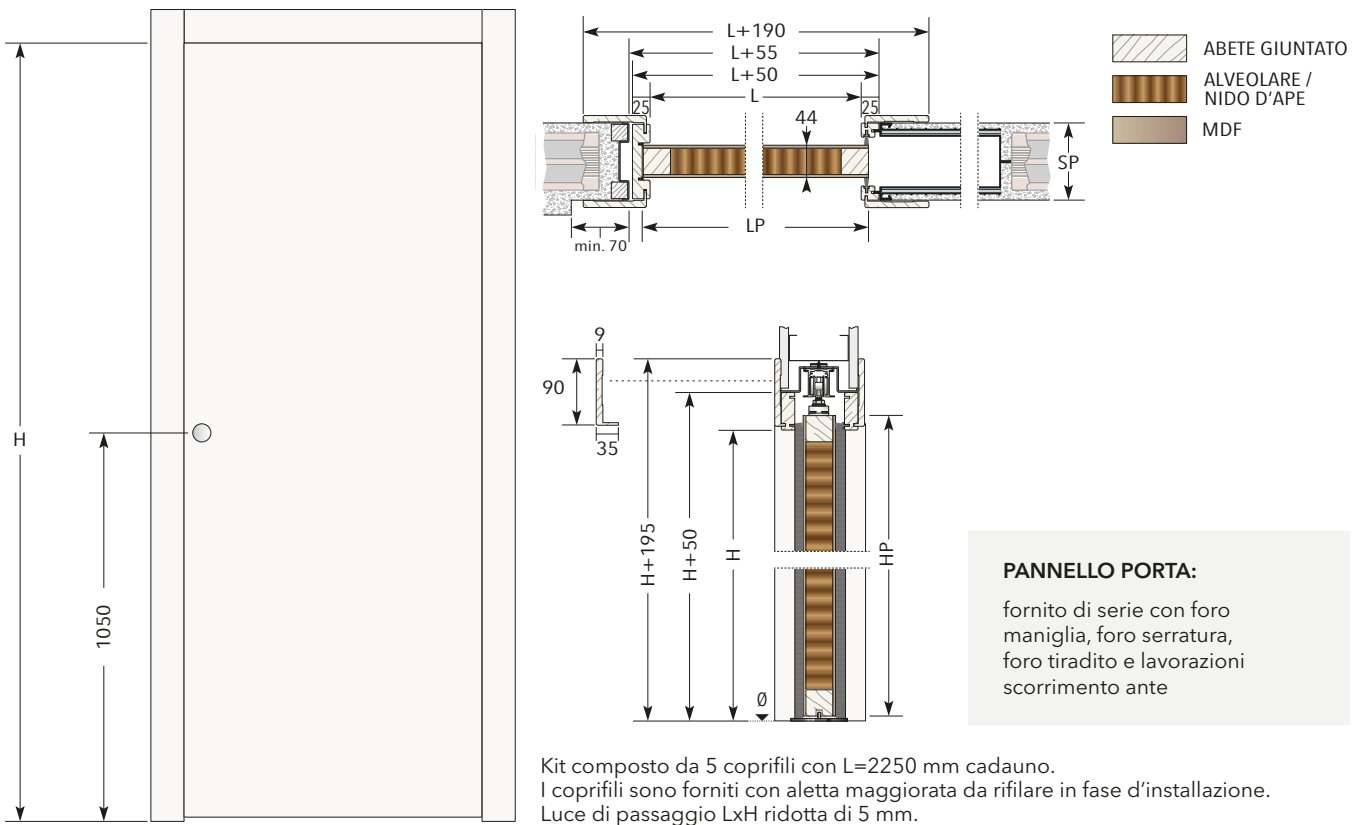

Stipite da 100/125/150 mm

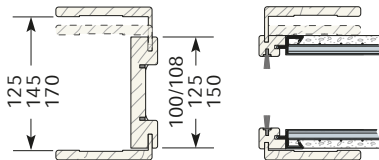

Compensatore da 25 mm

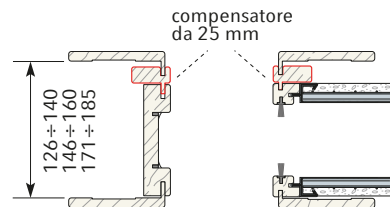

Compensatore da 60 mm

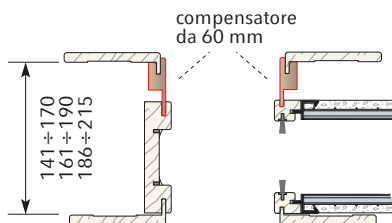

Compensatore da 220 mm

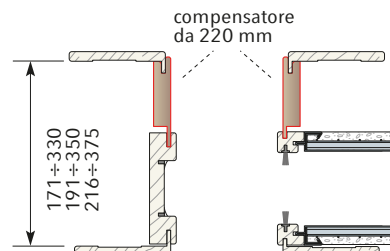

L	H	LP	HP
600	2100	613	2103
650	2100	713	2103
700	2100	713	2103
750	2100	813	2103
800	2100	813	2103
850	2100	913	2103
900	2100	913	2103
950	2100	1013	2103
1000	2100	1013	2103

Misure espresse in mm

APPLICAZIONI | ECLISSE Classic Collection - variante POP

VERSIONE PER INTONACO

Parete Finita 108 mm - Tramezza 80 mm

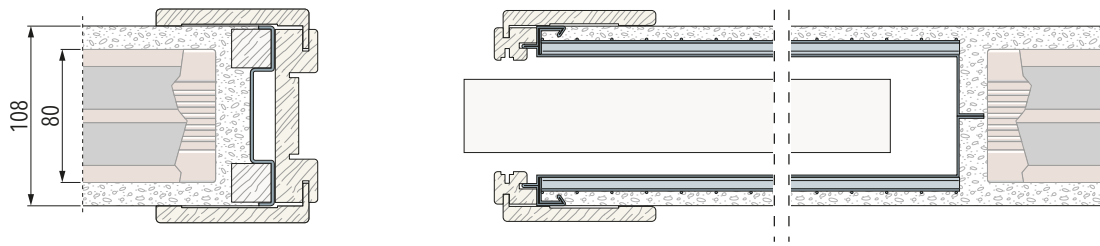

Parete Finita 125 mm - Tramezza 100 mm

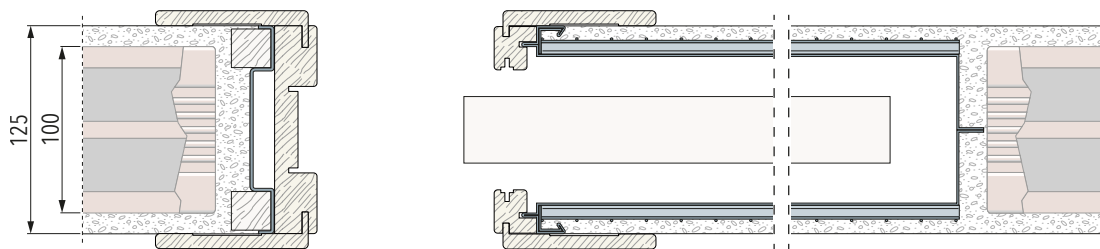

Parete Finita 150 mm - Tramezza 120 mm

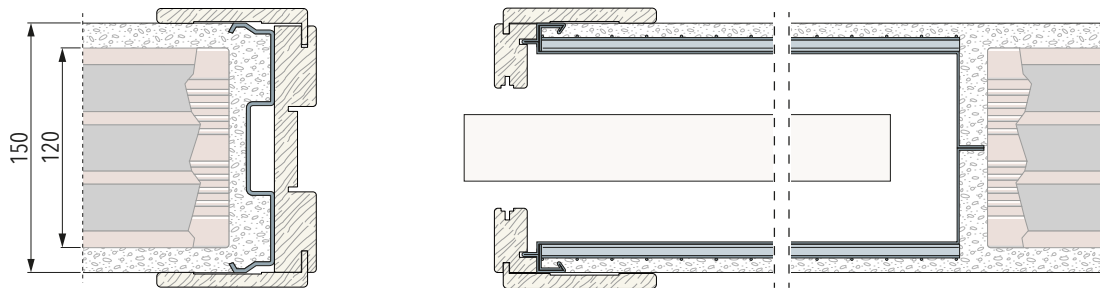

VERSIONE PER CARTONGESSO - Parte 1/2

Lastra singola: Parete Finita 100 mm - Orditura 75 mm | Controtelaio e stipiti da 100 mm

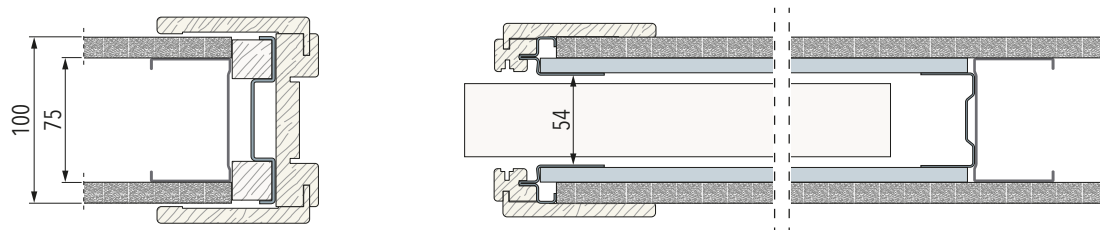

APPLICAZIONI | ECLISSE Classic Collection - variante POP

VERSIONE PER CARTONGESSO - Parte 2/2

Lastra doppia: Parete Finita 125 mm - Orditura 75 mm | Controtelaio e stipiti da 100 mm

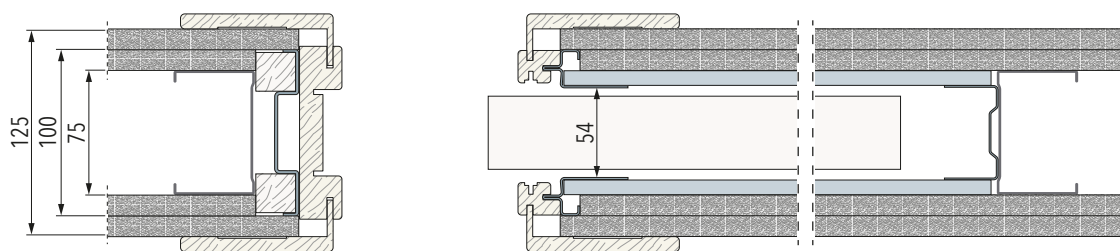

Lastra singola su cassone: Parete Finita 125 mm - Orditura 75 mm | Controtelaio e stipiti da 125 mm

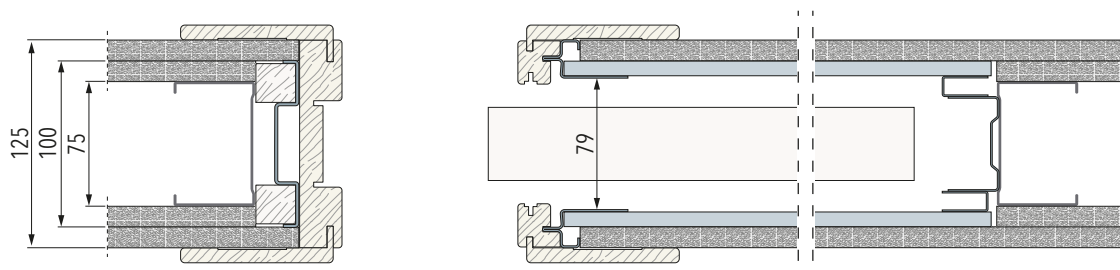

Lastra doppia: Parete Finita 150 mm - Orditura 100 mm | Controtelaio e stipiti da 125 mm

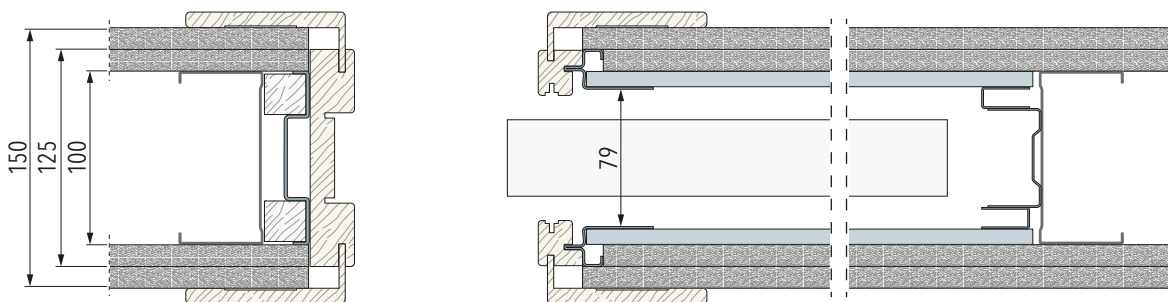

Lastra singola su cassone: Parete Finita 150 mm - Orditura 100 mm | Controtelaio e stipiti da 150 mm

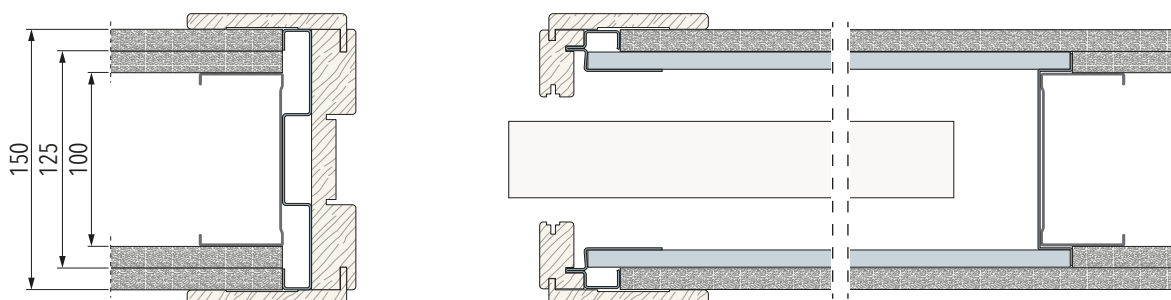

Porte **LEGNO** | ECLISSE **Classic Collection** - variante **POP**

PORTA BATTENTE

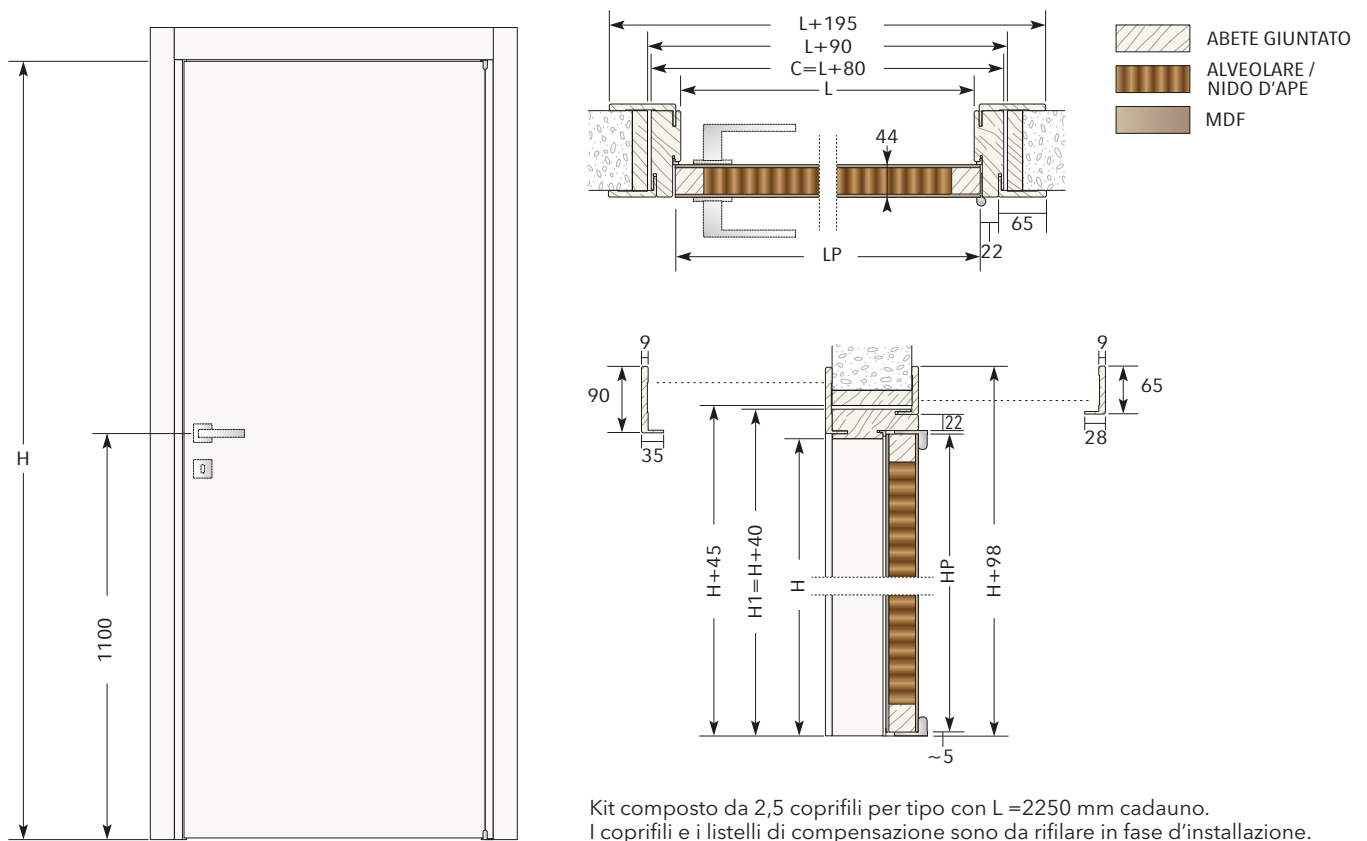

SP 100 mm (stipite da rifilare)

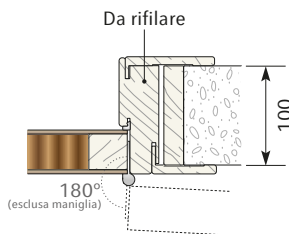

SP 108 mm - standard

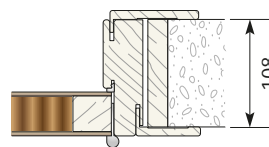

SP 125 mm - standard

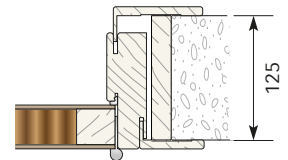

Compensatore da 25 mm

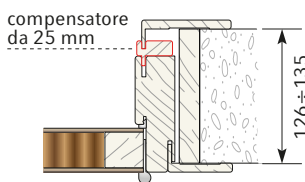

Compensatore da 60 mm

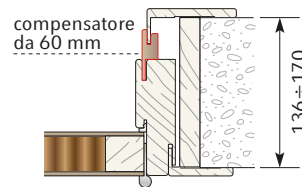

Compensatore da 220 mm

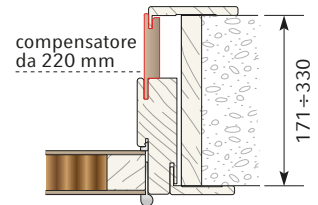

L	H	C	H1	LP	HP
600	2100	680	2140	613	2103
650	2100	730	2140	663	2103
700	2100	780	2140	713	2103
750	2100	830	2140	763	2103
800	2100	880	2140	813	2103
850	2100	930	2140	863	2103
900	2100	980	2140	913	2103
950	2100	1030	2140	963	2103
1000	2100	1080	2140	1013	2103

Misure espresse in mm