

ECLISSE SYNTESIS® EI30 BATTENTE

TIPOLOGIE

SCELTA DI APERTURA



PORTA A SPINGERE

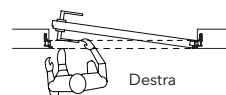
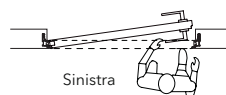

PORTA A TIRARE

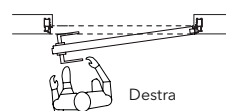
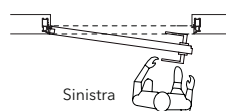

SOLO TELAIO CON TRAVERSO

ECLISSE SYNTESIS® EI30 BATTENTE è disponibile solo nella versione con traverso.

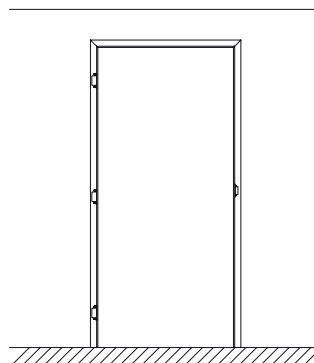
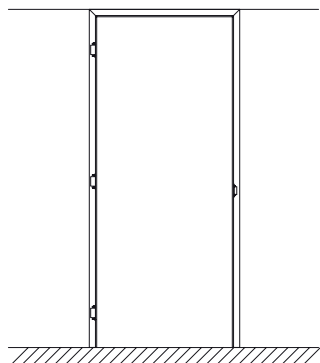

ECLISSE SYNTESIS® EI30 BATTENTE

APPLICAZIONI

Il telaio si adatta sia alle pareti in muratura che alle pareti in cartongesso.
Per pareti in cartongesso il telaio si fissa con le viti all'orditura metallica attraverso i fori già presenti.

PORTA A SPINGERE

PORTA A TIRARE

Telaio su parete per intonaco

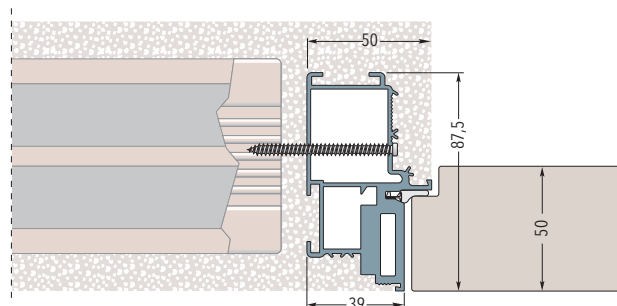
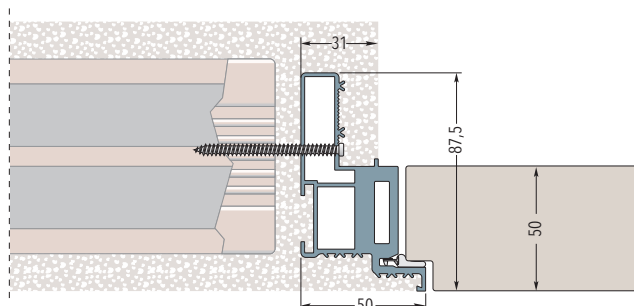

Telaio su parete in cartongesso con una lastra - Spessore parete finita 100 mm

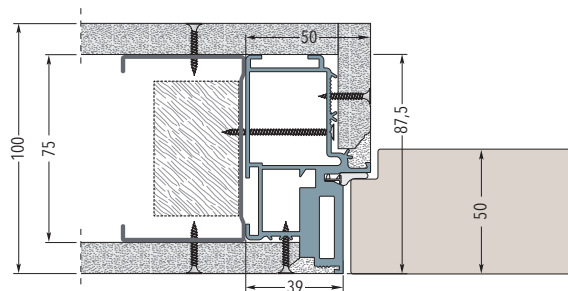
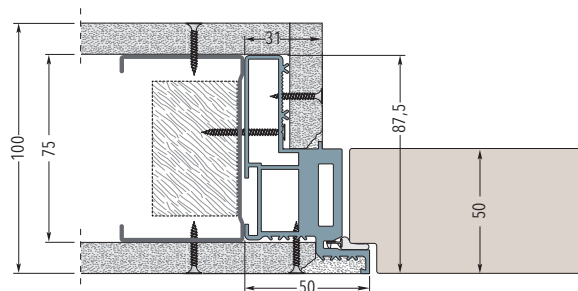

Telaio su parete in cartongesso con due lastre - Spessore parete finita 100 mm

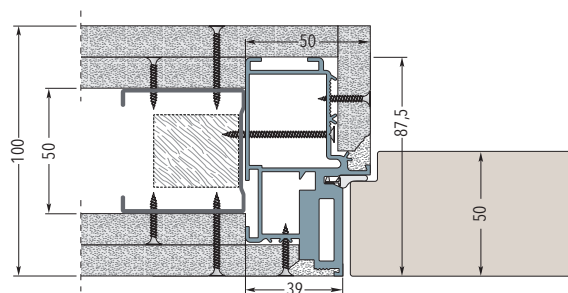
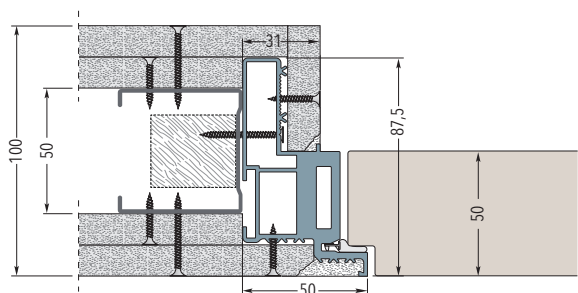

Telaio su parete in cartongesso con due lastre - Spessore parete finita 125/150 mm

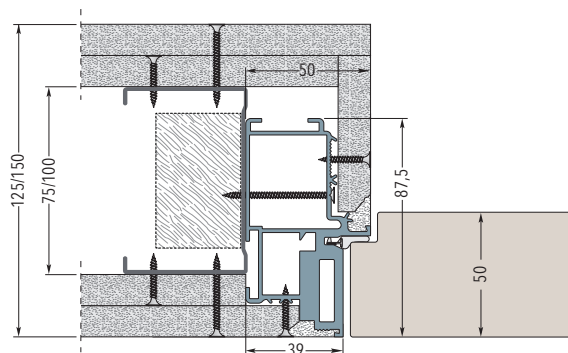
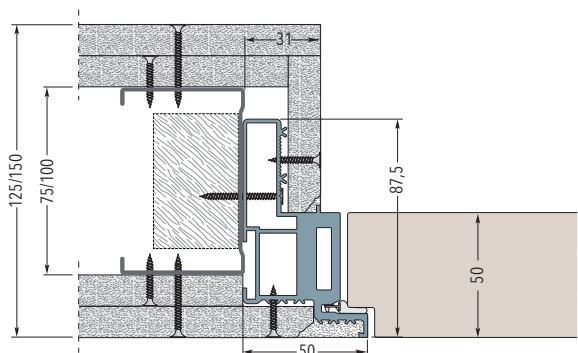

ECLISSE SYNTESIS® EI30 BATTENTE

DIMENSIONI

PORTA A SPINGERE

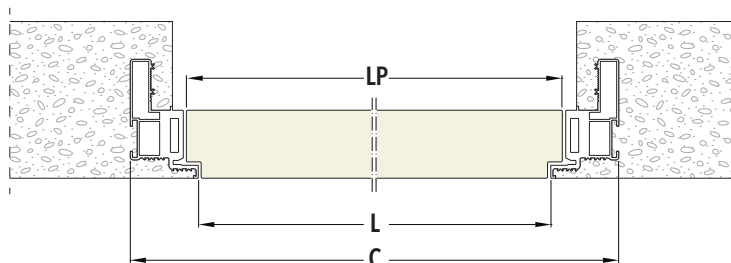
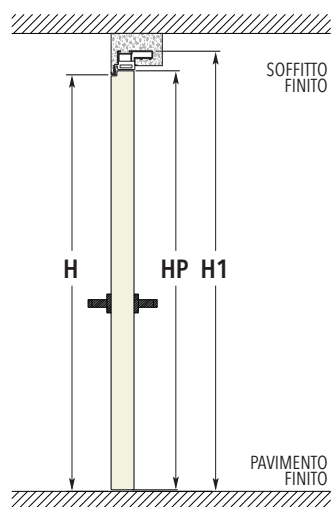

PORTA A TIRARE

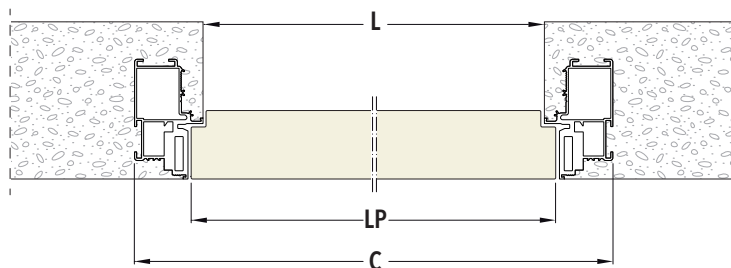
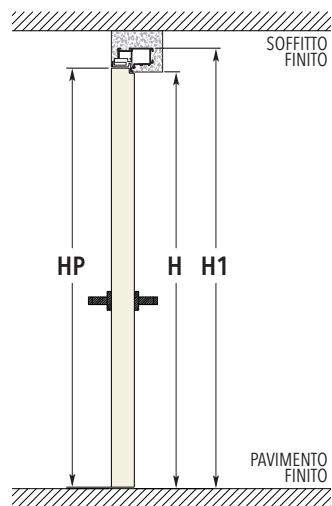

DIMENSIONI

LUCE DI PASSAGGIO		MISURE D'INGOMBRO		PANNELLO PORTA - SP. 50 mm	
L	H	C	H1	LP	HP
600	2000/2100	700	2050/2150	616	2004/2104
650	2000/2100	750	2050/2150	666	2004/2104
700	2000/2100	800	2050/2150	716	2004/2104
750	2000/2100	850	2050/2150	766	2004/2104
800	2000/2100	900	2050/2150	816	2004/2104
850	2000/2100	950	2050/2150	866	2004/2104
900	2000/2100	1000	2050/2150	916	2004/2104
950	2000/2100	1050	2050/2150	966	2004/2104
1000	2000/2100	1100	2050/2150	1016	2004/2104

Misure espresse in mm

LEGENDA

- L** Luce passaggio in larghezza
- H** Luce passaggio in altezza
- C** Massimo ingombro in larghezza
- H1** Massimo ingombro in altezza
- LP** Larghezza pannello porta
- HP** Altezza pannello porta

TECNICA

- ▶ H min 1650 mm; H max 2700 mm
- ▶ Realizzazioni con intervalli ogni 50 mm in L e 50 mm in H
- ▶ ECLISSE SYNTESIS® EI30 BATTENTE è disponibile solo con traverso
- ▶ Specificare richiesta predisposizione chiudiporta DORMA ITS96 EN2-4
- Il telaio arriva predisposto per 2 cerniere Tectus

ACCESSORI

- ▶ Chiudiporta